



Quadro Vino

Design Reg. n. TO 2012/41

Design e tecnologia si fondono per dar vita al primo quadro refrigerato mai realizzato al mondo.
Un oggetto assolutamente innovativo, dal design raffinato, capace di rendere speciale ogni ambiente in cui è inserito.

Design and technology combined to create the first refrigerated framework ever made in the world. An object absolutely innovative, sophisticated design, able to make special every environment in which it is inserted.

Design et technologie ensemble pour créer le premier cadre réfrigéré jamais réalisé dans le monde. Un objet absolument innovant, design sophistiqué, capable de rendre spécial tout environnement dans lequel il est inséré.

Eine Kombination aus Design und Technologie um diese Weltneuheit zu schaffen, das erste gekühlte Bild. Ein absolut innovatives Objekt mit anspruchvollem Design, es ist in der Lage jede Umgebung einzigartig zu gestalten.

Diseño y tecnología se combinan para crear el primer marco refrigerado jamás hecho en el mundo. Un objeto absolutamente innovadora, diseño sofisticado, capaz de realizar todo tipo de ambiente en el que se inserta.

Quadro Vino



QV12



QV30



QV40



QV52

Il Quadro Vino permette di conservare e servire vini diversi alla giusta temperatura. La refrigerazione è ottenuta con un silenzioso impianto termoelettrico dal consumo molto limitato. La minima profondità consente l'installazione anche in spazi molto ridotti, e fa del Quadro Vino il primo frigorifero al mondo che può essere appeso sopra un divano. È possibile scegliere modello, colori e finiture per confezionare un oggetto sempre unico.

QUADRO VINO allows to store and serve different wines at the right temperature. Refrigeration is obtained by a silent thermoelectric system with a very low energy consumption. The reduced depth allows installation in small spaces, and makes QUADRO VINO the first refrigerator in the world that can be hung over a sofa. It is possible to choose model, color and finish to realize an object always unique.

QUADRO VINO permet de stocker et servir différents vins à la bonne température. La réfrigération est obtenue par un système thermoélectrique silencieux à la consommation d'énergie très faible. La profondeur réduite permet une installation dans de petits espaces, et rends QUADRO VINO le premier réfrigérateur dans le monde qui peut être accroché sur un canapé. Il est possible de choisir le modèle, couleur et les finitions pour réaliser un objet toujours unique.

Quadro Vino zum lagern und servieren der verschiedenen Weinsorten in der richtigen Temperatur. Die Kühlung erfolgt mittels eines sehr leisen Thermoelektrischen System mit sehr geringen Verbrauch. Seine Mindestdiefe ermöglicht die Installation in kleinen Räumen und macht den Quadro Vino zum ersten Kühlschrank der Welt, der über einem Sofa gehängt werden kann. Mann kann Modell, Farbe und Ausführung wählen um ein einzigartiges Objekt zu besitzen.

El Quadro Vino para conservar y servir diferentes vinos a la temperatura adecuada. Refrigeración se obtiene con un sistema termoeléctrico silencioso y consumo muy limitado. La profundidad mínima permite la instalación en espacios pequeños, y hace que Quadro Vino es el primer frigorífico en el mundo que puede ser colgado sobre un sofá. Se puede elegir el modelo, el color y el acabado en manera de obtener un objeto único.

... amico dell'ambiente

... environmentally friendly • ... écologique
... Umweltfreundlich • ... Ecológico



Il Quadro Vino ha un impianto di refrigerazione ecologico privo di gas inquinanti ed è costruito con materiali riciclabili. La sostituzione dei componenti è semplice e rende conveniente la riparazione affinché il Quadro Vino, come un semplice quadro, possa accompagnarci per tutta la vita.

QUADRO VINO has an ecological refrigeration system free of polluting gases and it is made with recyclable materials. The replacement of its components is simple and any eventual repair is worthy, in order that your QUADRO VINO, like a real painting, will stay with you for all life long.

QUADRO VINO dispose d'un système de réfrigération écologique sans présence de gaz polluants et il est produit avec des matériaux recyclables. Le remplacement de ses composants est simple et digne de toute réparation éventuelle, afin que votre QUADRO VINO, comme un vrai tableau, pourra rester avec vous pour toute la vie.

Der Quadro Vino hat eine ökologische Kälteanlage, frei von umweltschädlichen Gase mit recyclebaren Materialien gebaut. Der Ersatz der Komponente ist ganz einfach und ermöglicht somit günstige Reparaturen, damit der Quadro Vino, so wie ein echtes Bild uns ein ganzes Leben lang begleiten kann.

El Quadro Vino tiene una unidad de refrigeración ecológica desprovisto de los gases contaminantes y es construido con materiales reciclables. La sustitución de los componentes es simple y hace conveniente las reparaciones en manera que el Quadro Vino, como un marco simple, nos acompañará toda la vida.

... riconoscimenti

... Awards • ... Attribution prix
... Auszeichnungen • ... premios



Il Quadro Vino è stato il vincitore del premio innovazione 2014 nel concorso Horeca 24. (gruppo Sole 24 Ore)
Quadro Vino was the winner of the Innovation Award 2014 in the competition Horeca 24. (Group Sole 24 Ore)
Quadro Vino a été le gagnant du Prix de l'Innovation 2014 dans la compétition Horeca 24. (Groupe Sole 24 Ore)
Quadro Vino war der Gewinner des Innovationspreises 2014 des Wettbewerbs Horeca 24. (Gruppe Sole 24 Ore)
Quadro Vino fue el ganador del Premio a la innovación 2014 en el concurso Horeca 24. (Grupo Sole 24 Ore)



Il Quadro Vino è stato l'unico prodotto non francese selezionato ed ammesso al Vip Club del Salone Equip'Hotel di Parigi
Quadro Vino was the only non-French product selected and admitted to the VIP Club Lounge at Equip'Hotel Paris
Quadro Vino était le seul produit non-français sélectionné et admis au VIP CLUB Lounge à Equip'Hôtel Paris
Quadro Vino war das einzige nicht-Französische Produkt, das ausgewählt und im VIP Club Lounge bei der Equip'Hotel in Paris zugelassen wurde.
El Quadro Vino fue el único producto no-francés seleccionado y admitido en el VIP Club Lounge en Equip'Hotel en Paris



In Expo 2015, Love It, sceglie Parete Vino e Quadro Vino per rappresentare l'eccellenza del prodotto enogastronomico italiano.
At Expo 2015, Love It choose Parete Vino and Quadro Vino to represent the excellence of Italian enogastronomy products.
À Expo 2015, Love It a choisi Parete Vino et Quadro vino pour représenter l'excellence des produits enogastronomiques Italiens.
Auf der Expo 2015, wählt Love It die Parete Vino und Quadro Vino um die Exzellenz der italienischen enogastronomischen Produkte zu vertreten.
En la Expo 2015, Love It seleccione Parete Vino y Quadro Vino para representar la excelencia de los productos enogastrónomicos italianos.

... i componenti

... Components
 ... Composants
 ... Bestandteile
 ... Componentes



struttura

structure • structure • Struktur • estructura



B
RAL 9010

bianco
white
blanche
Weiß
blanco



N
RAL 9005

nero
black
noir
schwarz
negro



colore luce

light colour • Coloris lumière • Lichtfarbe • color luz

B
○○○

LED bianco naturale
white natural daylight LED
LED blanc day-light naturel
LED naturweiß
LED blanco natural

U
●●●

LED blu
blue LED
LED bleu
Blaue LED
LED azul



cornici

frames • cadres • Rahmen • marcos



lineare bianca
linear white
linéaire blanc
Linear in Weiss
lineal blanco

RAL 9010
10



lineare nera
linear black
linéaire noir
Linear in Schwarz
lineal negro

RAL 9005
11



lineare marrone scuro
linear black brown
linéaire marron
Linear in Braun
lineal marrón

RAL 8022
12



classica argento patinato
classic style silver coated
classique revêtement argent
Klassisch Silber patiniert
clásico plata patinado

30



classica oro patinato
gold coated classic style
classique revêtement or
Klassisch Gold patiniert
clásico oro patinado

31

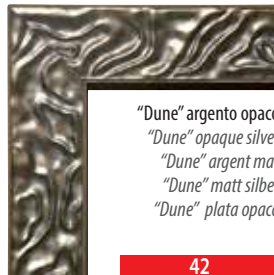

"Dune" argento opaco
"Dune" opaque silver
"Dune" argent mat
"Dune" matt silber
"Dune" plata opaca

42



"Dune" nero lucido
"Dune" glossy black
"Dune" noir brillant
"Dune" schwarz glänzend
"Dune" negro brillante

43



"Dune" bianco lucido
"Dune" glossy white
"Dune" blanc brillant
"Dune" weiß glänzend
"Dune" blanco brillante

44



pannelli

panels • panneaux • Platten • paneles



50

laminato bianco
white laminate
stratifié blanc
laminat weiß
laminado blanco

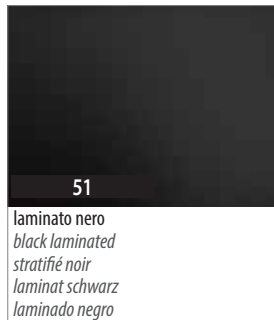

51

laminato nero
black laminated
stratifié noir
laminat schwarz
laminado negro



52

laminato alluminio
aluminium laminated
stratifié aluminium
mit Aluminium laminiert
laminado aluminio



60

eco pelle cross bianca
cross white eco leather
cuir écologique cross blanc
Öko-Leder in Weiß
cuero ecológico cross blanco



61

eco pelle cross nera
cross black eco leather
cuir écologique cross noir
Öko-Leder in Schwarz
cuero ecológico cross negro



62

eco pelle cross bronzo
cross bronze eco leather
cuir écologique cross bronze
Öko-Leder in Bronze
cuero ecológico cross bronzo



66

eco pelle pitone rosso
red python eco leather
cuir écologique python rouge
Python Öko-Leder in Rot
cuero ecológico pitón rojo



67

eco pelle pitone beige
beige python eco leather
cuir écologique python beige
Python Öko-Leder in Beige
cuero ecológico pitón beige

È possibile personalizzare il Quadro Vino abbinando i vari componenti. Tante diverse combinazioni per confezionare un oggetto davvero unico. Modulo d'ordine a pag. 142

It is possible to customize QUADRO VINO combining various components. So many different combinations to realize a unique object. Order form at page 142

Il est possible de personnaliser QUADRO VINO en combinant différents composants. Nombreuses combinaisons différentes pour réaliser un objet unique. Bon de commande à la page 142

Es ist möglich den Quadro Vino zu personalisieren indem man die verschiedene Komponente kombiniert. Viele verschiedene Kombinationen um immer ein einzigartiges Produkt zu gestalten. Bestellungsbogen auf Seite 142.

Hay la posibilidad de personalizar el Quadro Vino con la combinación de los distintos componentes. Diferente combinaciones para crear un objeto realmente único. Formulario de pedido página 142



Quadro Vino n. 12

Design Reg. n. TO 2012/41

Quadro Vino n. 12

Il Quadro Vino n. 12 è un espositore refrigerato per una bottiglia e due bicchieri.
 La minima profondità e l'installazione a parete ne consentono l'inserimento anche in spazi molto ridotti.
 È un oggetto studiato principalmente per la camera hotel ma straordinario in qualsiasi ambiente.
 Un'atmosfera unica e nuova che invita ad un brindisi veramente speciale.

*Quadro Vino No. 12 is a refrigerated cabinet housing a bottle and two glasses.
 The minimum depth and wall mounting allows it to be inserted even in very small space.
 It is an object designed mainly for the hotel room but extraordinary in any environment.
 A unique and new atmosphere that really calls for a special toast.*

*Le Cadre Vin n° 12 est un présentoir réfrigéré pour une bouteille et deux verres.
 La profondeur réduite et la pose murale permettent de l'installer dans des lieux très réduits.
 Il est un objet conçu principalement pour la chambre d'hôtel, mais extraordinaire dans toutes les ambiances.
 Une atmosphère nouvelle et unique qui vous invite à porter un toast très spécial.*

*Der Quadro Vino n. 12 ist eingekühlter Ausstellergeeignet für eine Flasche und zwei Gläser.
 Die geringe Tiefe und die Wandmontage ermöglichen es, diese Vitrine auch in engen Räumen zu installieren.
 Es wurde in erster Linie für das Hotelzimmer entwickelt, aber außergewöhnlich in jeder Umgebung.
 Ein einzigartiges und neues Ambiente das zu einem wirklich besonderen Toast einlädt.*

*El Quadro Vino n. 12 es un expositor refrigerante para una botella y dos copas.
 Su profundidad mínima y la instalación de pared, permiten colocarlo en espacios reducidos.
 Es un objeto diseñado principalmente para la habitación del hotel, pero extraordinario en cualquier entorno.
 Ambiente nuevo y único que invita a un brindis muy especial.*

... caratteristiche tecniche

... Technical features
 ... Spécifications techniques
 ... technische Daten
 ... Especificaciones técnicas

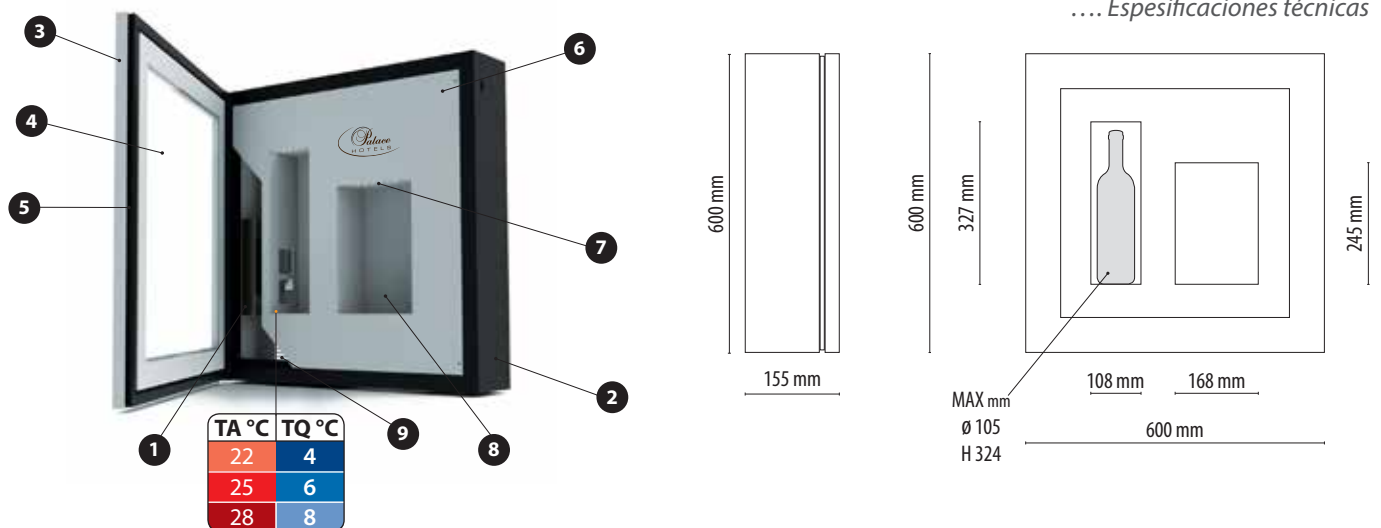

TA °C: temperatura ambiente • Ambient temperature • Température ambient • Raumtemperatur • Temperatura ambiente
TQ °C: temperatura Quadro Vino • Quadro Vino Temperature • Température Quadro Vino • Temperatur Quadro Vino • Temperatura Quadro Vin

- | | | | | |
|----------------------------|-------------------------|-------------------------------|---------------------------------------|---------------------------------|
| 1. Impianto termoelettrico | 1. Thermal power system | 1. Système thermoélectrique | 1. Kühlsystem Thermoelctrisch | 1. Instalación termoeléctrica |
| 2. Struttura in lamiera | 2. Sheet metal body | 2. Structure en tôle | 2. Struktur aus Stahlblech | 2. Estructura de chapa |
| 3. Cornice in legno / mdf | 3. MDF frame | 3. Cadre en MDF | 3. Rahmen aus Holz / MDF | 3. Marco en madera / MDF |
| 4. Vetrocamera 20 mm | 4. 20 mm double glazing | 4. Double vitrage 20 mm | 4. Mehrscheiben-Isolierglas von 20 mm | 4. Doble cristal 20 mm |
| 5. Guarnizione magnetica | 5. Magnetic gasket | 5. Joint magnétique | 5. Magnetdichtung | 5. Junta magnética |
| 6. Pannello in laminato | 6. Laminated panel | 6. Panneau en stratifié | 6. Laminatpaneel | 6. Panel de laminado |
| 7. Illuminazione a LED | 7. LED lighting system | 7. Éclairage à LED | 7. LED-Beleuchtung | 7. Iluminación por LED |
| 8. Vano non refrigerato | 8. Uncooled compartment | 8. Compartiment non réfrigéré | 8. Ungekühlte Wanne | 8. Compartimento no refrigerado |
| 9. Sbrinamento automatico | 9. Automatic defrosting | 9. Dégivrage automatique | 9. Automatische Abtauung | 9. Descongelamiento automático |

Legenda • Legend • Légende • Legende • Leyenda pag. 116

CODE										
QV12		+6	600 x 600 x 155	1	2	●	●	100 - 240	48	21

... la collezione



QV12-B1050B/U



QV12-B1066B/U



QV12-B1062B/U



QV12-B1250B/U



QV12-B1260B/U



QV12-B1267B/U



QV12-B3150B/U



QV12-B3160B/U



QV12-B3162B/U



QV12-B4250B/U



QV12-B4350B/U



... The collection
... La collection
... Die Kollektion
... La colección



QV12-N1151B/U



QV12-N1166B/U



QV12-N1152B/U



QV12-N1051B/U



QV12-N3051B/U



QV12-N3061B/U



QV12-N3151B/U



QV12-N3161B/U



QV12-N4451B/U



QV12-N4251B/U



QV12-N4351B/U





Quadro Vino n. 30

Design Reg. n. TO 2012/41

Quadro Vino n. 30

Il Quadro Vino n. 30 permette di esporre 3 bottiglie di spumante e mantenerle a giusta temperatura di servizio. Su questo modello è possibile scegliere l'opzione dell'esposizione in verticale delle bottiglie ideale per un servizio al bicchiere.

The QUADRO VINO n. 30 allows you to expose 3 bottles of sparkling wine and keep them at the right temperature. On this model it is possible also to choose the option of placing the bottles vertically, ideal for service by the glass.

Le QUADRO VINO n. 30 vous permet d'exposer 3 bouteilles de vin mousseux et de les garder à la bonne température. Sur ce modèle, il est possible choisir l'option de l'exposition des bouteilles en vertical, idéal pour le service au verre.

Quadro Vino 30 ermöglicht es 3 Flaschen Sekt auszustellen und auf der richtigen Temperatur zu halten. Bei diesem Modell, ist es möglich die Option zu wählen Flaschen im Stehen zu lagern ideal für Wein im Glas Bedienung.

El Quadro Vino 30 le permite exponer 3 botellas de vino espumoso y mantenerlos a la temperatura adecuada. En este modelo es posible elegir la opción de la exposición en botellas en vertical, ideal para el servicio por copa.

... caratteristiche tecniche

... Technical features
... Spécifications techniques
... technische Daten
... Especificaciones técnicas

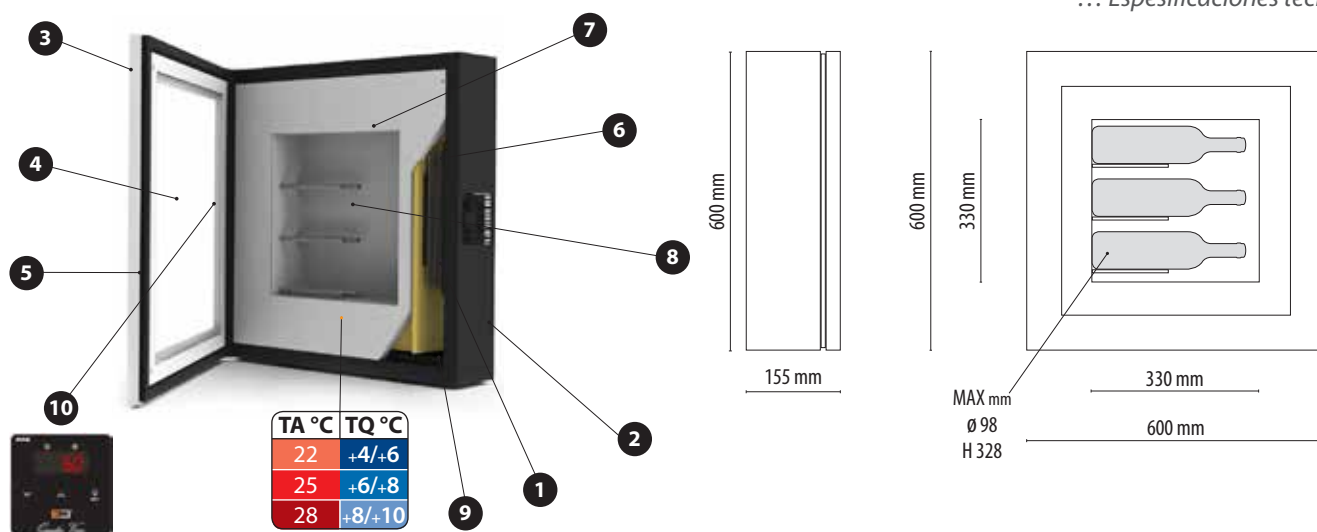

TA °C: temperatura ambiente • Ambient temperature • Température ambient • Raumtemperatur • Temperatura ambiente
TQ °C: temperatura Quadro Vino • Quadro Vino Temperature • Température Quadro Vino • Temperatur Quadro Vino • Temperatura Quadro Vin

1. Impianto termoelettrico	1. Thermal power system	1. Système thermoélectrique	1. Kühlsystem Thermoelktrisch	1. Instalación termoeléctrica
2. Struttura in lamiera	2. Sheet metal body	2. Structure en tôle	2. Strukturaus Stahlblech	2. Estructura de chapa
3. Cornice in legno / mdf	3. MDF frame	3. Cadre en MDF	3. Rahmen aus Holz / MDF	3. Marco en madera / MDF
4. Vetrocamera 20 mm	4. 20 mm double glazing	4. Double vitrage 20 mm	4. Mehrscheiben-Isolierglas von 20 mm	4. Doble cristal 20 mm
5. Guarnizione magnetica	5. Magnetic gasket	5. Joint magnétique	5. Magnetdichtung	5. Junta magnética
6. Pannello in laminato	6. Laminated panel	6. Panneau en stratifié	6. Laminatpaneel	6. Panel de laminado
7. Illuminazione a LED	7. LED lighting system	7. Éclairage à LED	7. LED-Beleuchtung	7. Iluminación por LED
8. Tondini alluminio	8. Aluminium rods	8. Tiges en aluminium	8. Aluminiumträger	8. barras de aluminio
9. Sbrinamento automatico	9. Automatic defrosting	9. Dégivrage automatique	9. Automatische Abtauung	9. Descongelamiento automático
10. Termoregolatore digitale	10. Digital thermoregulator	10. Thermoregulateur digital	10. Digitaler Thermoregler	10. Controlador digital de temperatura

Legenda • Legend • Légende • Legende • Leyenda pag. 116

CODE	❄️	🌡️ °C	📏 mm LxPxH	🍷	🍷	❄️	⚡	⚡	⚡	⚡	⚡	⚡
QV30	❄️	+4 / +10	600 x 600 x 155	3	0	●	●	100 - 240	98	21		

... la collezione



QV30-B1050B/U



QV30-B1066B/U



QV30-B1062B/U



QV30-B1250B/U



QV30-B1260B/U



QV30-B1267B/U



QV30-B3150B/U



QV30-B3160B/U



QV30-B3162B/U



QV30-B4250B/U



QV30-B4350B/U



... The collection
... La collection
... Die Kollektion
... La colección



QV30-N1151B/U



QV30-N1166B/U



QV30-N1152B/U



QV30-N1051B/U



QV30-N3051B/U



QV30-N3061B/U



QV30-N3151B/U



QV30-N3161B/U



QV30-N4451B/U



QV30-N4251B/U



QV30-N4351B/U





Quadro Vino n. 40

Design Reg. n. TO 2012/41

Quadro Vino n. 40

Il Quadro Vino n. 40 è un oggetto assolutamente innovativo, dal design raffinato, capace di rendere speciale qualsiasi ambiente. Trova facile inserimento nel ristorante e nell'hotel ma anche nelle residenze private. Su questo modello è possibile scegliere l'opzione dell'esposizione in verticale delle bottiglie ideale per un servizio al bicchiere.

The QUADRO VINO n. 40 is an object totally new, with a innovative design, capable of making special any ambient. It can be installed in restaurants and hotels as well as in private residences. On this model you can choose the option of exhibiting the bottles vertically, ideal for a service to the glass.

Le QUADRO VINO n. 40 est un objet totalement nouveau, design raffiné, capable de rendre tout ambiance spécial. Peut être installé dans le restaurant, l'hôtel ainsi que dans des résidences privées. Sur ce modèle, vous pouvez choisir l'option d'exposition des bouteilles en vertical, idéale pour le service vin au verre.

Der Quadro Vino 40 ist ein komplett neues Modell, der in der Lage ist mit seinem raffiniertem Design jede Umgebung fabelhaft zu gestalten. Passt ganz gut in Restaurants, Hotels aber auch in Privathäuser. Bei diesem Modell, ist es möglich die Opzion zu wählen Flaschen im Stehen zu lagern ideal für Wein im Glas Bedienung.

El Quadro Vino 40 es un objeto totalmente nuevo, de diseño refinado, capaz de hacer cualquier ambiente especial. Encuentra fácil inclusión en el restaurante y el hotel, así como en residencias privadas. En este modelo se puede elegir la opción de la exposición en vertical de las botellas, ideal para un servicio al vidrio.

... caratteristiche tecniche

... Technical features
... Spécifications techniques
... technische Daten
... Especificaciones técnicas

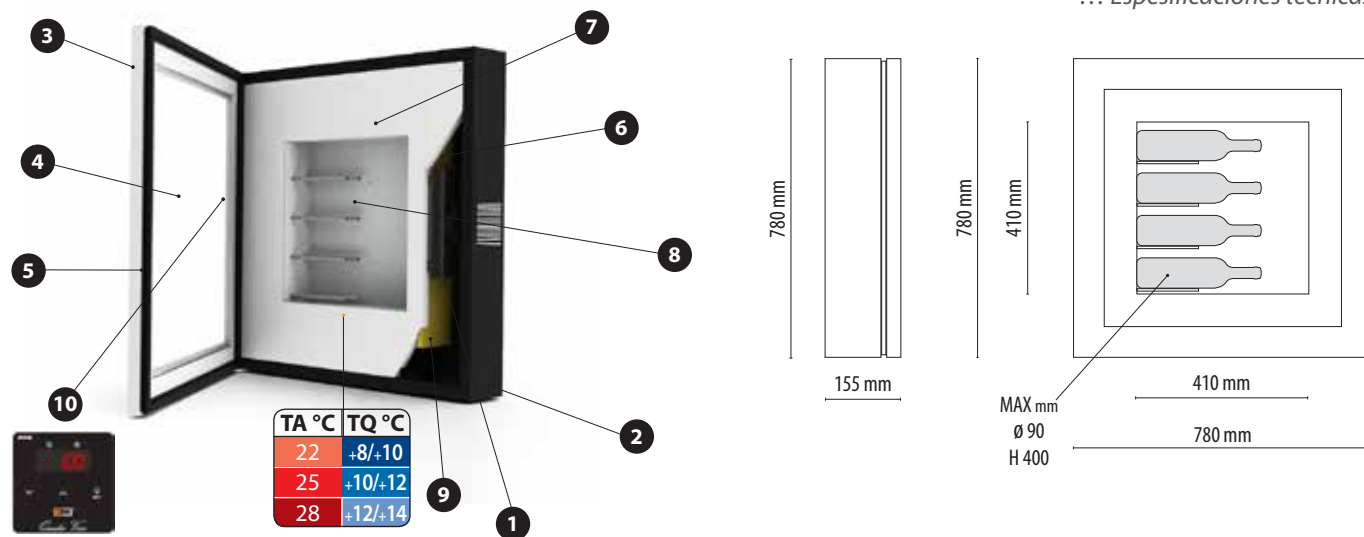

TA °C: temperatura ambiente • Ambient temperature • Température ambient • Raumtemperatur • Temperatura ambiente
TQ °C: temperatura Quadro Vino • Quadro Vino Temperature • Température Quadro Vino • Temperatur Quadro Vino • Temperatura Quadro Vin

1. Impianto termoelettrico	1. Thermal power system	1. Système thermoélectrique	1. Kühlsystem Thermoelektrisch	1. Instalación termoelectrica
2. Struttura in lamiera	2. Sheet metal body	2. Structure en tôle	2. Struktur aus Stahlblech	2. Estructura de chapa
3. Cornice in legno / mdf	3. MDF frame	3. Cadre en MDF	3. Rahmen aus Holz / MDF	3. Marco en madera / MDF
4. Vetrocamera 20 mm	4. 20 mm double glazing	4. Double vitrage 20 mm	4. Mehrscheiben-Isolierglas von 20 mm	4. Doble cristal 20 mm
5. Guarnizione magnetica	5. Magnetic gasket	5. Joint magnétique	5. Magnetdichtung	5. Junta magnética
6. Pannello in laminato	6. Laminated panel	6. Panneau en stratifié	6. Laminatpaneel	6. Panel de laminado
7. Illuminazione a LED	7. LED lighting system	7. Éclairage à LED	7. LED-Beleuchtung	7. Iluminación por LED
8. Tondini alluminio	8. aluminium rods	8. Tiges en aluminium	8. Aluminiumträger	8. barras de aluminio
9. Sbrinamento automatico	9. Automatic defrosting	9. Dégivrage automatique	9. Automatische Abtauung	9. Descongelamiento automático
10. Termoregolatore digitale	10. Digital thermoregulator	10. Thermoregulateur digital	10. Digitaler Thermoregler	10. Controlador digital de temperatura

Legenda • Legend • Légende • Legende • Leyenda pag. 116

CODE	Icon: Snowflake	Icon: Thermometer	Icon: Box with dimensions	Icon: Bottle	Icon: Glass	Icon: Water droplets	Icon: Warning triangle	Icon: Voltage	Icon: Power	Icon: Weight
QV40	❄️	+10 / +12	780 x 780 x 155	4	0	●	●	100 - 240	98	29

... la collezione



QV40-B1050B/U



QV40-B1066B/U



QV40-B1062B/U



QV40-B1250B/U



QV40-B1260B/U



QV40-B1267B/U



QV40-B3150B/U



QV40-B3160B/U



QV40-B3162B/U



QV40-B4250B/U



QV40-B4350B/U



... The collection
... La collection
... Die Kollektion
... La colección



QV40-N1151B/U



QV40-N1166B/U



QV40-N1152B/U



QV40-N1051B/U



QV40-N3051B/U



QV40-N3061B/U



QV40-N3151B/U



QV40-N3161B/U



QV40-N4451B/U



QV40-N4251B/U



QV40-N4351B/U





Quadro Vino n. 52

Design Reg. n. TO 2012/41

Quadro Vino n. 52

Il Quadro Vino n. 52 è un espositore climatizzato per cinque bottiglie e due bicchieri, un nuovo modo di esporre, conservare e servire il vino. Aprire un quadro, prendere una bottiglia di vino e servirla ad una temperatura di 16 °C è un'azione assolutamente nuova che non avremmo mai pensato possibile. È uno speciale complemento d'arredo che, inserito in cucina o nel salotto, piuttosto che nella sala di un ristorante o di un hotel, non può passare inosservato.

The QUADRO VINO n. 52 is a refrigerated display for five bottles and two glasses, a new way to display, store and serve wine. Open the frame, take a bottle of wine and serve it at a temperature of 16 °C is an action totally new that we never thought possible. It is a special piece of furniture that, added to the kitchen or living room, rather than in the dining room of a restaurant or an hotel, can not go unnoticed.

Le QUADRO VINO n. 52 est une vitrine réfrigérée pour cinq bouteilles et deux verres, une nouvelle façon d'exposer, stocker et servir le vin. Ouvrir un cadre du tableau, prendre une bouteille de vin et le servir à une température de 16 °C est une action totalement nouvelle que nous ne pensions pas possible. Il est un détail de l'ameublement spécial qui, inséré dans la cuisine ou le salon, plutôt que dans la salle à manger d'un restaurant ou d'un hôtel, ne peut passer inaperçu.

Der Quadro Vino 52 ist ein gekühlter Aussteller geeignet für 5 Flaschen und 2 Gläser, eine neue Möglichkeit Wein zu lagern, kühlen und servieren. Ein Wandgemälde öffnen eine Flasche herausnehmen und einen guten Wein bei einer Temperatur von 16 Grad genießen, ist etwas, das wir bis jetzt nicht für möglich gehalten haben. Es ist eine besondere Ergänzung für Ihre Einrichtung und kann in der Küche, im Wohnzimmer oder im Speisesaal eines Restaurants oder Hotels ausgestellt werden. Stets wird er alle Blicke auf sich ziehen.

Quadro Vino n. 52 es un expositor climatizado para cinco botellas y dos copas, una nueva forma de exponer, conservar y servir el vino. Abrir un cuadro, tomar una botella de vino y servirla a una temperatura de 16 °C es una acción completamente nueva que jamás hubiesemos pensado que fuese posible. Es un complemento de decoración especial que, colocado en la cocina o en el salon, o bien en la sala de un restaurante o de un hotel, no pasara desapercibido.

... caratteristiche tecniche

... Technical features
... Spécifications techniques
... technische Daten
... Especificaciones técnicas

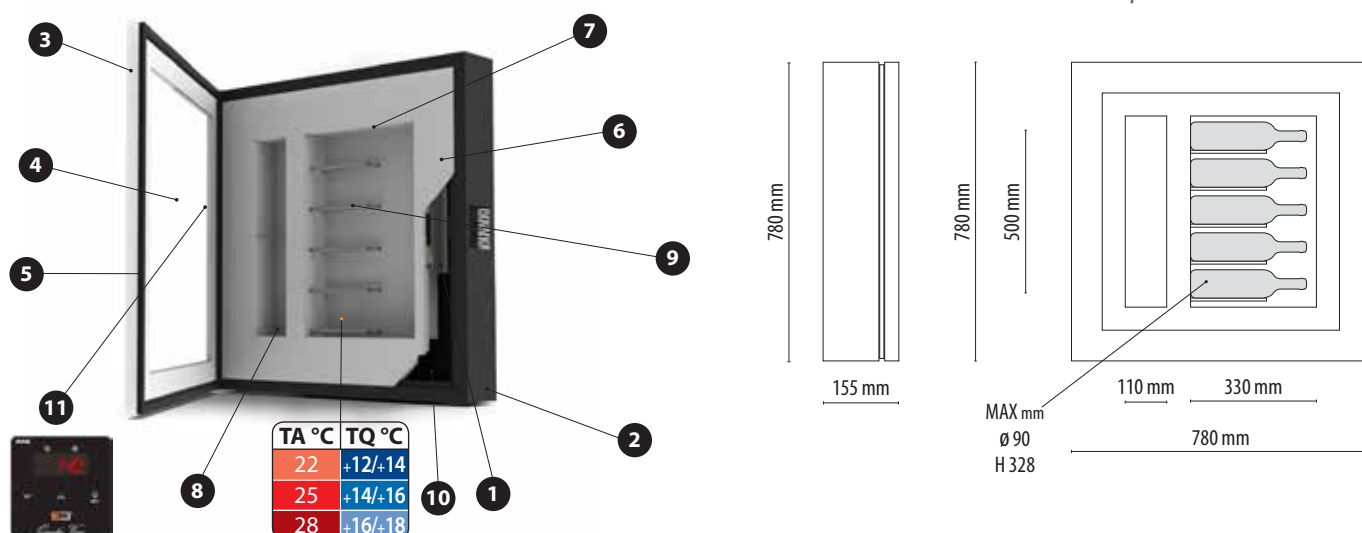

TA °C: temperatura ambiente • Ambient temperature • Température ambient • Raumtemperatur • Temperatura ambiente
TQ °C: temperatura Quadro Vino • Quadro Vino Temperature • Température Quadro Vino • Temperatur Quadro Vino • Temperatura Quadro Vin

1. Impianto termoelettrico	1. Thermal power system	1. Système thermoélectrique	1. Kühlsystem Thermoelctrisch	1. Instalación termoeléctrica
2. Struttura in lamiera	2. Sheet metal body	2. Structure en tôle	2. Strukturaus Stahlblech	2. Estructura de chapa
3. Cornice in legno / mdf	3. MDF frame	3. Cadre en MDF	3. Rahmen aus Holz / MDF	3. Marco en madera / MDF
4. Vetrocamera 20 mm	4. 20 mm double glazing	4. Double vitrage 20 mm	4. Mehrscheiben-Isolierglas von 20 mm	4. Doble cristal 20 mm
5. Guarnizione magnetica	5. Magnetic gasket	5. Joint magnétique	5. Magnetdichtung	5. Junta magnética
6. Pannello in laminato	6. Laminated panel	6. Panneau en stratifié	6. Laminatpaneel	6. Panel de laminado
7. Illuminazione a LED	7. LED lighting system	7. Éclairage à LED	7. LED-Beleuchtung	7. Iluminación por LED
8. Vano non refrigerato	8. Uncooled compartment	8. Compartiment non réfrigéré	8. Ungekühlte Wanne	8. Compartimento no refrigerado
9. Tondini alluminio	9. aluminium rods	9. Tiges en aluminium	9. Aluminiumträger	9. barras de aluminio
10. Sbrinamento automatico	10. Automatic defrosting	10. Dégivrage automatique	10. Automatische Abtauung	10. Descongelamiento automático
11. Termoregolatore digitale	11. Digital thermoregulator	11. Thermoregulateur digital	11. Digitaler Thermoregler	11. Controlador digital de temperatura

Legenda • Legend • Légende • Legende • Leyenda pag. 116

CODE	❄️	🌡️ °C	📏 mm LxPxH	🍷	🍷	💧	⚠️	⚡ V	⬇️ W	📊 Kg
QV52	❄️	+14 / +16	780 x 780 x 155	5	2	●	●	100 - 240	50	29

... la collezione



QV52-B1050B/U



QV52-B1066B/U



QV52-B1062B/U



QV52-B1250B/U



QV52-B1260B/U



QV52-B1267B/U



QV52-B3150B/U



QV52-B3160B/U



QV52-B3162B/U



QV52-B4250B/U



QV52-B4350B/U



... The collection
... La collection
... Die Kollektion
... La colección



QV52-N1151B/U



QV52-N1166B/U



QV52-N1152B/U



QV52-N1051B/U



QV52-N3051B/U



QV52-N3061B/U



QV52-N3151B/U



QV52-N3161B/U



QV52-N4451B/U



QV52-N4251B/U



QV52-N4351B/U



... optional

... optional
... options
... Zubehör
... accesorios

QV-OPT-BV

ALLESTIMENTO BOTTIGLIE VERTICALI
VERTICAL BOTTLES ACCOMODATION
LOGEMENT BOUTEILLES EN VERTICAL
VERTIKALE FLASCHENPOSITION
EQUIPO VERTICAL DE BOTELLAS



Sui modelli QV30 e QV40 è possibile richiedere l'optional allestimento bottiglie verticali. Durante la fase finale di costruzione vengono rimossi i tondini portabottiglie e sostituiti con degli appositi tappi affinché sia sempre possibile ripristinare l'allestimento standard con bottiglie orizzontali. Con questa soluzione si può utilizzare il Quadro Vino anche per il servizio al bicchiere in quanto è possibile inserire e mantenere a giusta temperatura anche le bottiglie già aperte.

On models QV30 and QV40 it is possible to have on request the optional of vertical fitting of the bottles. During the final phase of construction rods are removed and replaced with the appropriate caps so that you can always restore the standard configuration with horizontal bottles. With this solution you can use the QUADRO VINO for the service by the glass since you can enter and maintain the right temperature even for open bottles.

Sur les modèles QV30 et QV40 il est possible avoir sur demande l'option de logement vertical des bouteilles. Pendant la phase finale de construction les tiges sont supprimés et remplacés par des bouchons appropriés de sorte que vous pouvez toujours restaurer la configuration standard avec des bouteilles horizontales. Avec cette solution, vous pouvez utiliser le QUADRO VINO pour le service du vin au verre car vous pouvez saisir et de maintenir la bonne température, même les bouteilles ouvertes.

Bei den Modellen QV30 und QV40 ist es möglich die vertikale Flaschenposition auszuwählen. Die Alustäbe die als Flaschenhalter dienen werden in der Herstellung abgeschraubt und die Löcher werden mit Gummideckel geschlossen, so wird es immer möglich sein zur Standardausführung zurück zu kehren und die Alustäbe einzusetzen. Die vertikale Ausführung der Flaschen macht die Bedienung Wein im Glas möglich, da es auch möglich ist auch die Temperatur der geöffneten Flaschen zu halten.

En los modelos QV30 y QV40 es posible solicitar el accesorio opcional botellas verticales. Durante la fase final de construcción se retiran las barras botella y reemplazado con tapones para poder siempre restaurar la configuración estándar con botellas horizontales. Con esta solución se puede utilizar el Quadro Vino por el servicio de vino en copa porque se pueden introducir y mantener la temperatura adecuada también de botellas abiertas.

QV-OPT-QN

QUADRO VINO NEUTRO
NON REFRIGERATED QUADRO VINO
QUADRO VINO NEUTRE
QUADRO VINO NEUTRAL
QUADRO VINO NEUTRO

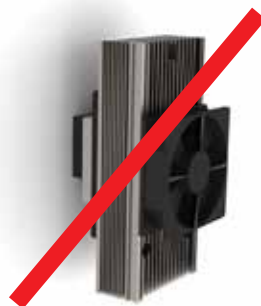

È possibile richiedere il Quadro Vino anche nella versione neutra. In questo caso vengono rimossi sia l'impianto di refrigerazione che il termoregolatore digitale posto nella parte laterale, al cui posto viene inserita una targa prodotto. L'illuminazione sarà gestita con interruttore dedicato.

It is possible to require QUADRO VINO also in the neutral version. In this case the refrigeration system and the digital thermoregulator are both removed, in the place of the thermoregulator is inserted a product label. The lighting will be operated by a dedicated switch.

Il est possible de demander QUADRO VINO également dans la version neutre. Dans ce cas, le système de réfrigération et le thermorégulateur digital sont tous deux éliminés, à la place du thermorégulateur est insérée une étiquette du produit. L'éclairage sera géré avec interrupteur dédié.

Man kann den Quadro Vino auch in einer Neutralen Version bestellen, Kühleinheit und digitaler Temperaturregler werden entfernt. Anstelle des Temperaturreglers, der sich seitlich befindet, wird dann eine Produktplakette eingesetzt. Die Beleuchtung wird mit eigenem Schalter betrieben.

Es posible pedir el Quadro Vino también en la versión neutral. En este caso se eliminan tanto del sistema de refrigeración que el termoregulator digital en la parte lateral, y en su lugar se introduce la placa del producto. La iluminación se gestionará con el interruptor dedicado.

Legenda



LEGEND



LÉGENDE



























LEGENDE



LEYENDA



CODE	Codice	Code	Code	Code	Código
	Temperatura (TA 25 °C - UR 50%)	Temperature (TA 25 °C - UR 50%)	Température (TA 25 °C - UR 50%)	Temperatur (TA 25 °C - UR 50%)	Temperatura (TA 25 °C - UR 50%)
	Umidità (TA 25 °C - UR 50%)	Humidity (TA 25 °C - UR 50%)	Humidité (TA 25 °C - UR 50%)	Feuchtigkeit (TA 25 °C - UR 50%)	Humedad (TA 25 °C - UR 50%)
	Versione	Versio n	Version	Version	Versión
	Refrigerato	Cooled	Réfrigéré	Kühlvitrine	Refrigerado
	Neutro	Neutral	Neutre	Neutralvitrine	Neutro
	Piastre eutettiche	Eutectic plates	Plaques eutectiques	Eutektische Platten	Placas eutécticas
	Riscaldato	Heated	Chauffant	Beheizt	Calentado
	Ventilato	Ventilated	Ventilé	Belüftet	Ventilado
	Tensione	Voltage	Tension	Spannung	Tensión
	Assorbimento	Absorption	Absorption	Stromaufnahme	Absorción
	Sbrinamento automatico	Automatic defrosting	Dégivrage automatique	Abtauautomatik	Desescarche automático
	Evaporazione automatica della condensa	Automatic evaporation of condensation	Évaporation automatique de la condensation	Automatische Verdunstung des Kondenswassers	Evaporación automática del vapor condensado
	Modello compressore	Compressor type	Modèle du compresseur	Kompressor Modell	Modelo de compresor
	Gas refrigerante	Refrigerant gas	Gaz réfrigérant	Kühlgas	Gas refrigerante
	Numero piastre eutettiche	Number of eutectic plates	Nombre de plaques eutectiques	Anzahl eutektischer Platten	Número de placas eutécticas
	Luce	Light	Lumière	Beleuchtung	Luz
	Led bianco naturale	white natural daylight LED	LED blanc day-light naturel	LED naturweiß	LED blanco natural frio
	Led bianco caldo	brightwhite warm LED	LED blanc chaud	LED warmweiß	LED blanco cálido
	Led blu	Blue LED	LED bleue	Blaue LED	Led azul
	Led colorati con telecomando	Coloured LEDs with remote control	LED couleurs à télécommande	Farbige LED mit Fernbedienung	Led de colores con control remoto
	Colore	Colour	Coloris	Farbe	Color
	Finitura metallo	Metal finish	Finition métal	Metallbeschichtung	Acabado metal
	Nikel satinato	Satin nickel	Nickel satiné	Satin Nickel	Níquel satinado
	Oro lucido	Glossy gold	Doré brillant	Glänzendes Gold	Oro brillante
	Lato posteriore vetrina	Showcase back side	Face postérieure vitrine	Rückseite der Vitrine	Lado trasero vitrina
	Ante in vetro	Glass doors	Porte en verre	Glastür	Hoja de cristal
	Pannello cieco	Blank panel	Panneau borgne	Abschlussplatte	Panel ciego
	Numero piani (base compresa)	Number of shelves (including base)	Nombre de tablettes (base comprise)	Anzahl Etagen (Grundplatte eingeschlossen)	Número de pisos (incluida la base)
	Installazione	Installation	Installation	Installation	Instalación
PM	Appoggio - incasso	Support - built-in system	A poser - encastré	Auflage – Einbau	Apoyado - Encajado

					
PC	Centrale	Central	Centrale	Mitte	Central
	Numero cassetti	Number of drawers	Nombre de tiroirs	Anzahl Kassetten	Número de cajones
	Numero ante	Number of doors	Nombre de portes	Anzahl Türen	Número de hojas
	Struttura Quadro Vino	Structure Quadro Vino	Structure Quadro Vino	Aufbau Quadro Vino	Estructura Quadro Vino
	Cornice quadro vino	Quadro Vino frame	Cadre du Quadro Vino	Rahmen Quadro Vino	Marco Quadro Vino
	Pannello quadro vino	Quadro Vino panel	Panneaux Quadro Vino	Platte Quadro Vino	Panel Quadro Vino
	Allestimento	Fitting-out	Aménagement	Aufhängung	Disposición
A	Bottiglie con colli esterni	Bottles with outer necks	Bouteilles avec goulots sur l'extérieur	Flaschen mit Hälsen nach Außen	Botellas con cuellos hacia el exterior
B	Bottiglie con colli passanti	Bottles with inserted necks	Bouteilles avec goulots passants	Flaschen mit Hälsen nach Innen	Botellas con cuellos encajados
C	Bottiglie inclinate	Inclined bottles	Bouteilles inclinées	Geneigte Flaschen	Botellas inclinadas
D	Piani regolabili	Adjustable shelves	Tablettes réglables	Einstellbare Etagen	Estantes ajustables
E	Bottiglie frontali	Bottles frontal positioning	Positionnement frontal	Frontale Flaschenausstellung	Botellas frontal
SL	Salumeria	Delicatessen	Charcuterie	Wurstwaren	Charcuteria
GS	Gastronomia	Gastronomy	Gastronomie	Gastronomie	Gastronomia
CL	Cioccolato	Chocolate	Chocolat	Schokolade	Chocolate
	Bottiglie	Bottles	Bouteilles	Flaschen	Botellas
	Bicchieri	Glasses	Verres	Gläser	Copas
	Kit salumeria	Salami kit	Kit salaisons	Bausatz für Wurstwaren	Kit charcutería
	Colore spalla	Shoulder colour	Coloris côté	Farbe der Seitenwände	Color lateral
	Presente	Present	Présent	Vorhanden	Presente
-	Assente / dato non disponibile	Absent / data not available	Absent / information non disponible	Nicht vorhanden / nicht verfügbar	Ausente / dato no disponible
OPT	Optional	Optional	En option	Optional	Opcional
	Dimensioni nette	Net dimensions	Dimensions nettes	Kantenlänge	Dimensiones netas
	Dimensioni con imballo	Dimensions including packaging	Dimensions avec emballage	Abmessung mit Verpackung	Dimensiones con embalaje
	Dimensioni con imballo su pedana	Dimensions including packing on pallet	Dimensions avec emballage sur palette	Abmessung mit Verpackung auf Gestell	Dimensiones con embalaje sobre plataforma
	Peso netto	Net weight	Poids net	Netto-Gewicht	Peso neto
	Peso con imballo	Weight with packaging	Poids avec emballage	Gewicht mit Verpackung	Peso con embalaje
	Peso con imballo su pedana	Weight with packing on pallet	Poids avec emballage sur palette	Gewicht mit Verpackung auf Gestell	Peso con embalaje sobre plataforma
	Volume con imballo	Volume with packaging	Volume avec emballage	Volumen mit Verpackung	Volumen con embalaje
	Volume con imballo su pedana	Volume with packaging on pallet	Volume avec emballage sur palette	Volumen mit Verpackung auf Gestell	Volumen con embalaje sobre plataforma
	Imballo in legno	Wooden packaging	Emballage en bois	Holzverpackung	Embalaje de madera
DS	Descrizione	Description	Description	Beschreibung	Descripción